

AD-EB Series

Electrical Press Brakes with Belt



Perfect Precision

Low Energy Consumption

High Capacity

Elegant Design



As a total supplier for sheet metal manufacturing with almost 70 years of experience, Durma understands and recognizes the challenges, requirements and expectations of the industry. We strive to satisfy the ever higher demands of our customers by continuously improving our products and processes while researching and implementing the latest technologies

In our three production plants with a total of 150.000 m² we dedicate 1,000 employees to delivering high quality manufacturing solutions at the best performance-to-price ratio in the market.



PRODUCTION IS
MORE EFFECTIVE NOW

From the innovations developed at our Research & Development Center to the technical support given by our worldwide distributors, we all have one common mission: to be your preferred partner.

Durmazlar offers it's machines to the world markets under the Durma brand.



1

High technology,
modern production
lines



2

Top quality
components

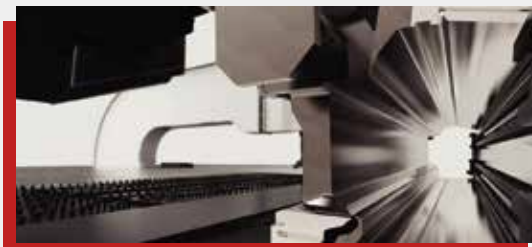

3

High quality
machines designed
in R&D Centre

AD-EB

AD-EB Series Electric Press Brake

Environment Friendly

DURMA AD-EB CNC PRESS BRAKE serial can provide the production starting from 2500 mm table width to 3050 mm table width. It is also possible to apply different sizes in line with customer demands. The machine body is bolted and processed with precision tables.

The reducer drive system, high torque-resistant bearings provide high precision bending results.



Production is *More Effective Now.*

ENVIRONMENT FRIENDLY LOW COST HIGH GAIN

- Excellent bending results
- Minimum tool change and adjustment time
- Maximum speed and safety



High Capacity

Robust Body

Perfect Precision

Winning

Ergonomic

Advantages

- High-energy saving
- Decreased operating costs
- Reduced cooling effort
- Operational reliability
- High availability
- Lower investment System
- Future-oriented technology
- Remarkable noise reduction
- Fewer requirement for measures
- Ease of integration of check functions
- Decreased maintenance costs
- Compliance with EU standards

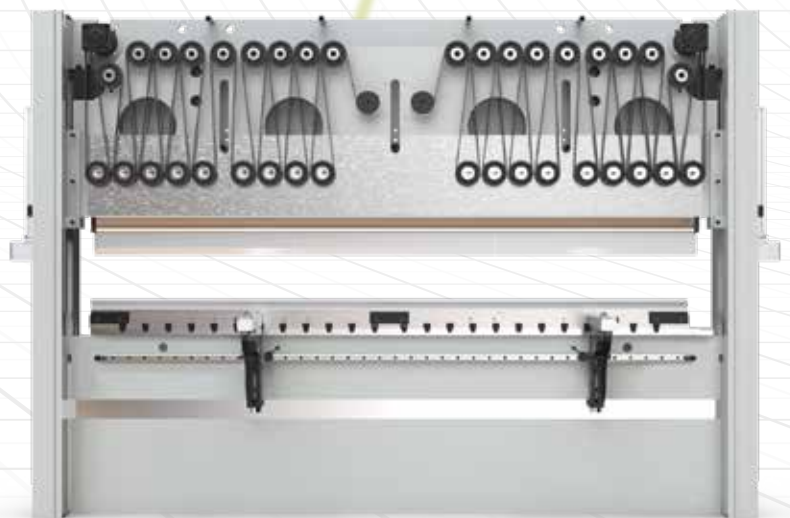

AD-EB

HIGH INCREASE IN PRODUCTION EFFICIENCY

Our AD-EB series solutions provide high energy savings to our business with speed, efficiency, quality, and low power consumption.

- Energy saving
- Same consistency in each cycle
- Economic
- Repeatability at high speed



STRONG BACK GAUGE SYSTEM

- Precise
- Reliable
- Strong

- Fast and high accuracy
- Safe movement
- Long-life linear motion elements
- No maintenance required
- Simple to use, easy to maintain



X 650 X R (AL) BACK GAUGE

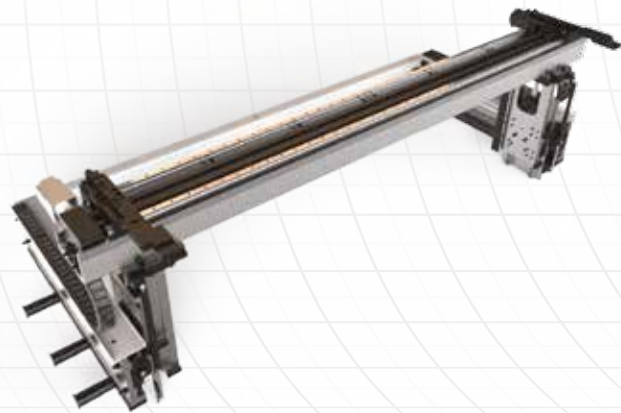

X 650 X R Z1 Z2 (AL) BACK GAUGE

- AD-EB back gauge systems are long-lasting, precise, and resistant to impacts.
- The high-speed back gauge system moving with ballscrew is also supported with linear guides.

Why DURMA Back Gauge?

The most important factor that affects bending quality is the stability and the design of the back gauge. Perfect bending, perfect product is possible through a stable and precise back gauge.

The high-speed back gauge system moving with ballscrew is also supported with **double** linear guides. Thus, long life, precision, and strength against collisions are provided.

The back gauge finger is designed to achieve all types of bendings in maximum stability.

TOOL HOLDERS AND TOOLS

The bending performance of the machine is increased by using a High-Quality European type clamping system and ease of use is provided.

The lower body is designed as narrow for Z-type bending and designed in accordance with the European type tool holding system.

DURMA is your solution partner with various tool options.



European Clamping System

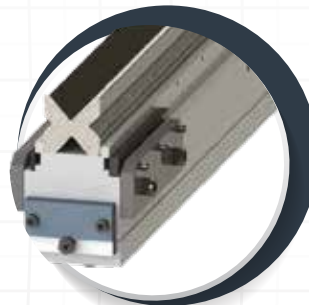

European Type Bottom Tool (4V Die)



Quick Release Clamping

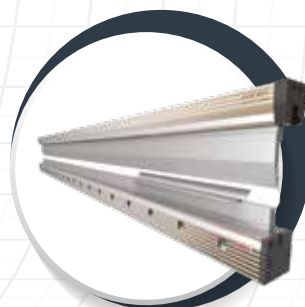

DURMA Hydraulic Holder



DURMA Top Tool Holder

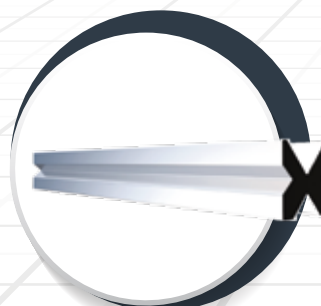

DURMA Multi V Bottom Tool

Production is *More Effective Now.*

SAFE AND PRECISE BENDS WITH TOP QUALITY EQUIPMENT

■ CE Safety Systems

Our machines are designed in accordance with European CE standards and directives in order to ensure your safety with hydraulic, electric, appropriate height covers and laser light curtains. CE safety in tandem machines is provided with light barriers.



CE Laser Safety System

■ Aluminum Sheet Supporting System

The strong front arm can be moved to the right and left and fixed at the desired position with a linear slide and roller system. With aluminum miter and bar support, the sheet material can be easily moved to the machine.



Front Sheet Support System with Linear Guide and Aluminum Miter



BENDING IS EASIER NOW

On the control unit's powerful simulation screen, the bending position can be monitored instantaneously and the bending parameters can interfere. The blanking of the parts to be bent in CNC, back gauge positions, bending order, the compatibility of the bending parts with the stroke, and the tools required for bending angles are automatically performed by the control unit on condition that the material information is defined.

There is also the possibility to monitor the bends in three dimensions according to the type of the control unit and whether there is any collision during the bending or not.

■ DA-66T (Standard)



- 2D graphical touch screen programming mode
- 3D visualisation in simulation and production
- 17" high resolution colour TFT
- Full Windows application suite
- Delem modusys compatibility
- USB, peripheral interfacing
- User specific application support within the controllers multitasking environment
- Sensor bending & correction interface
- Profile - TL - software

■ DA-69S (Optional)



- 24" TFT screen, 1920 x3080 pixels, 32 bit colour,
- Real-time Linux embedded OS
- Full touch screen control
- Storage capacity 2 GB
- Network connectivity
- Delem modusys compatible
- Tandem operation
- 2D/3D real-scale product programming and visualisation
- Automatic bending calculation 2D/ 3D
- DXF part & tool import support

Production is *More Effective Now.*

■ DURMA Angle Measurement System



■ Automatic AP3 - AP4 Sheet Follower

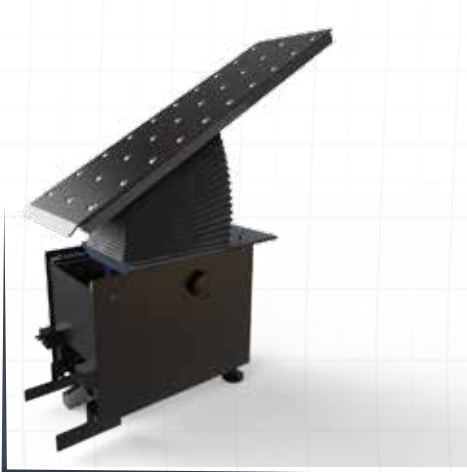

■ Robotic System of Applications



AD-EB

Advantages Compared to the Classical Press Brake

PRESS GROUP

- Motor - Reducer Coupled
- System Belt - Pulley Tackle System

Equipment Advantages

- Simpler Drive Group
- Fewer Components
- Easy and Fast Assembly
- Easy and Quick Maintenance
- Hydraulic Oil-Free Drive System
- Body Structure with No Crowning Requirement



AD-EB Series Technical Details

Machine Types	Bending Force	Bending Length	Distance Between Columns	Stroke	Daylight	Working Height	Approaching Speed	Bending Speed	Return Speed	Back Gauge X Axis Length	Back Gauge R Axis Length	Length	Width	Height	Weight
Unit	Ton	mm	mm	mm	mm	mm	mm/s	mm/s	mm/s	mm	mm	mm	mm	mm	kg
AD-EB 2580	80	2550	2840	320	500	1085	105	10-20*	105	650	250	3700	2200	2550	6400
AD-EB 30135	135	3050	3340	320	500	1085	100	10-20*	100	650	250	4200	2200	2550	7300

*According to CE Norm, the bending speed should be a maximum of 10 mm/sec, except for robot-aided use.

Standard & Optional Equipment

Standard Equipment

Control Unit - DA-66T
 Y1, Y2, X, R (4 -Axis) X=650mm Back Gauge (AI - Double Guide)
 F.AKAS LC 5 Safety system
 Servo motor back gauge & linear guided & ballscrew system (X-R)
 European type tool holding system
 Sliding front arms (With T-Slot and stopper) With full-length linear slide
 World quality electric equipment

Optional Equipment

Control Unit - DELEM - 69S touch screen
 Motorised X,R,Z1,Z2 Axis back gauge system
 X = 650mm X, R, Z1, Z2, Delta X +/- 125 mm CNC
 Controlled (AL) X axis = 1000 mm - Back protection with light barriers
 Durma laser angle measurement
 DBEND 3D bending edit and simulation
 Quick Clamping System
 Hydraulic tool holding system
 Robot integration
 Additional back gauge finger and additional sliding front arms
 Central lubrication manual/automatic
 Special packaging for overseas shipments

AD-EB

PRODUCTION IS MORE EFFECTIVE NOW



Production is *More Effective Now.*

FAST ON SERVICE AND SPARE PARTS





DURMA provides the best level of service and spare parts with qualified personnel and spare parts in stock. Our experienced and professional service personnel are always ready at your service. Our professional training and application enriched courses will give you an advantage to use our machinery.

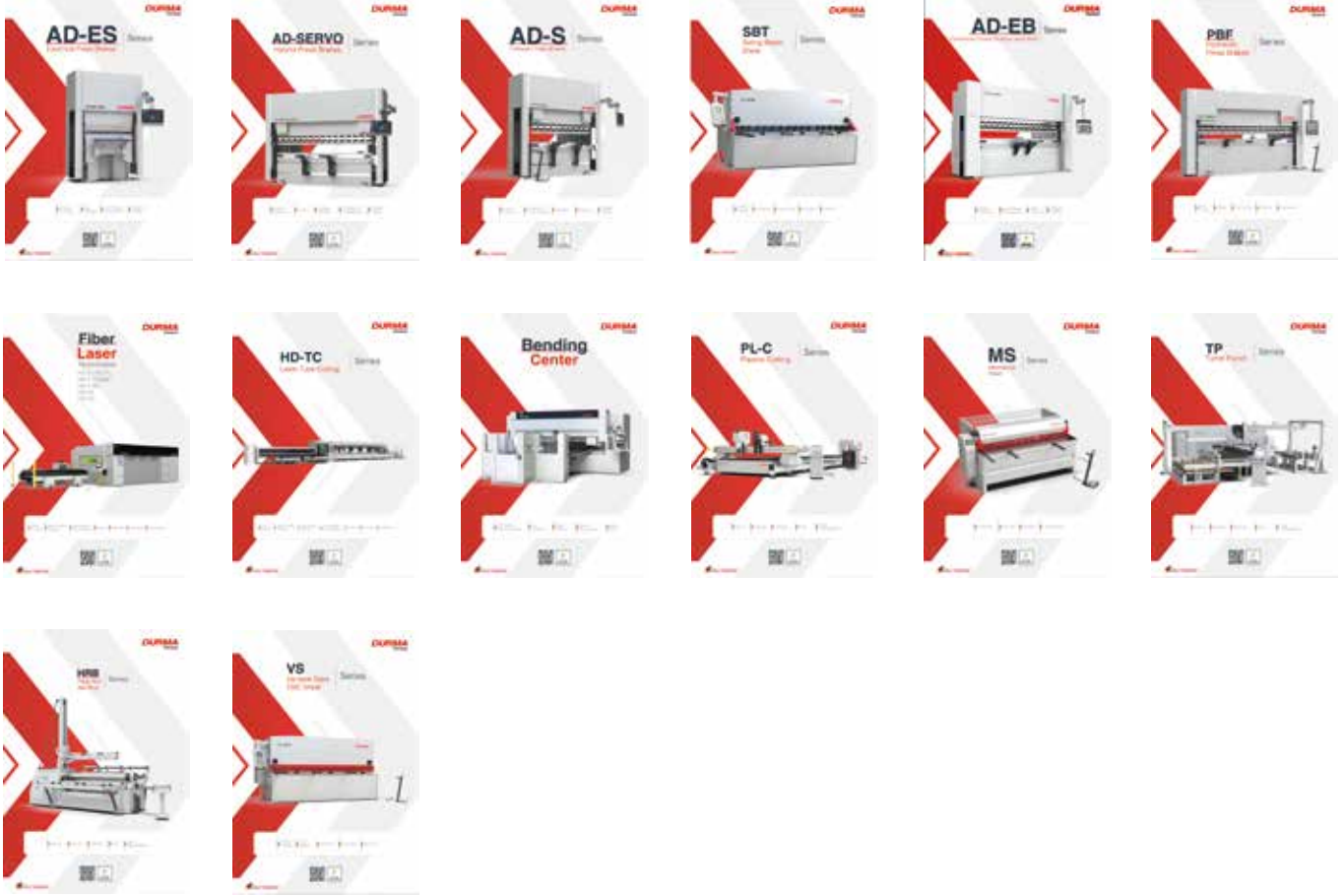

Product Groups

DURMA



-  Durma International
-  durmainternational
-  durmaint
-  durmamachines
-  Durmazlar



EN 2024/04/V02



Durmazlar Makina San. ve Tic. A.Ş.
OSB 75. Yıl Bulvarı Nilüfer-Bursa /
Türkiye
P: +90 224 219 18 00
F: +90 224 242 75 80
info@durmazlar.com.tr

www.durmazlar.com.tr

Durmazlar Makina San. Tic. A.Ş. has right to change catalogue values and machine technical details without notice.